

WINDOWS Eco 68

Basic information

Eco

Eco windows always have a visible aluminum external drip cap.

The Softline finish includes an additional aluminum drip cap mounted on the sash.

Standard drip caps colours: white, brown, silver, olive.

* available installation depths:
68, 78 i 92 mm.



Finish type

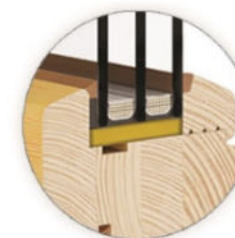

Softline



Retro



Thermal transmittance U_w

1,01 - 1,37 W/m²K



Security / Burglary resistance

Rc1 - Rc2 class



Sound insulation

(depending on the glazing unit used)
32 - 41 dB



Wind load resistance

C5 class

WINDOWS
Eco 68
RAL



RAL paint – Frame / Sash / Drip caps

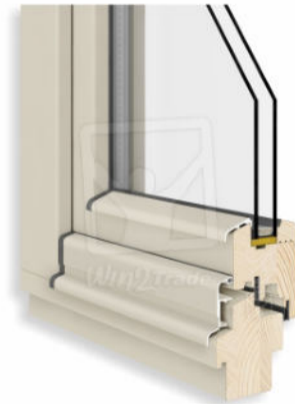
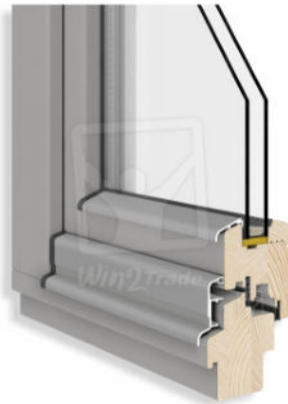
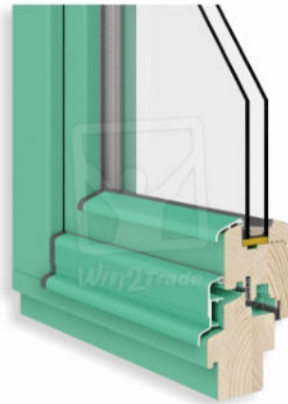

WINDOWS Eco 68

Basic information

CONSTRUCTION

Wooden frame made of glued laminated timber along the length and thickness from solid sawn timber.

Frame and sash installation depth: 68mm
(78 and 92 mm are also available)

MATERIAL



pine

meranti

oak

GLASS

Energy-saving double- or triple-glazed units (double-chamber) made of low-emissivity glass with an argon-filled inter-pane space.



OPTIONAL :

- safety glass: laminated VSG, tempered ESG
- soundproof
- solar control
- maximum glazing package thickness for 68 mm profile is 32mm

LAZURES



EQUIPMENT

STANDARD:

The basic model of the handle for Eco windows is the Hoppe metal handle, model **Tokyo** in white or brown.

OPTIONAL:

- handles that increase safety, such as handles with button or handles with key
- handles with a lockable turned-opening
- vents mounted horizontally in the sash
- muntins: inter-pane, glued on, vienna bars and construction bars



PAINTING

The joinery is painted with water-based, eco-friendly, transparent or opaque varnishes.

OPAQUE COLOURS according to the RAL or NCS palette
LAZURES highlight the wood structure.



* As standard, the colour inside and outside is identical.

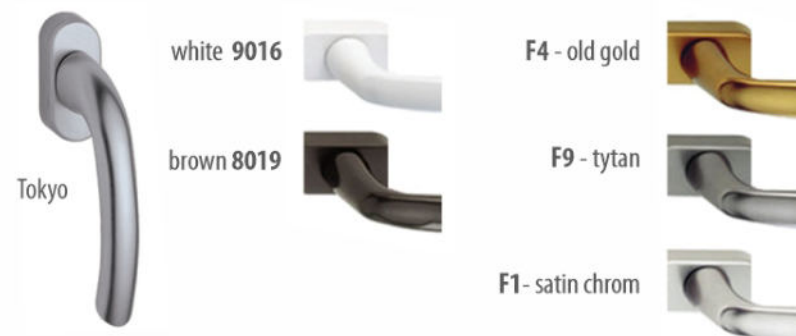

with key

with button

Hoppe handles – other models



Atlanta

Luxemburg

New York

WINDOWS Eco 68

Basic cross-sections (Softline)

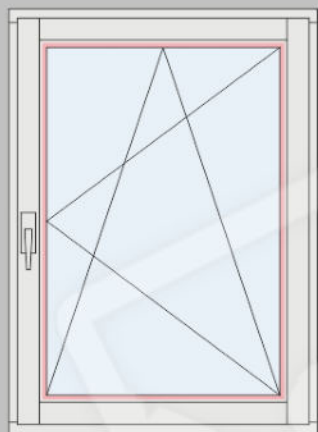

Eco Softline



frame / sash

OPTIONS GLAZING BEAD

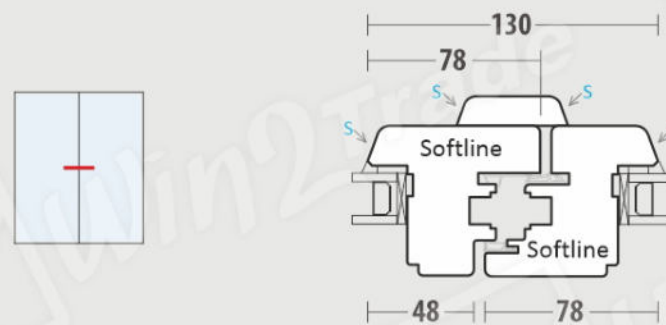
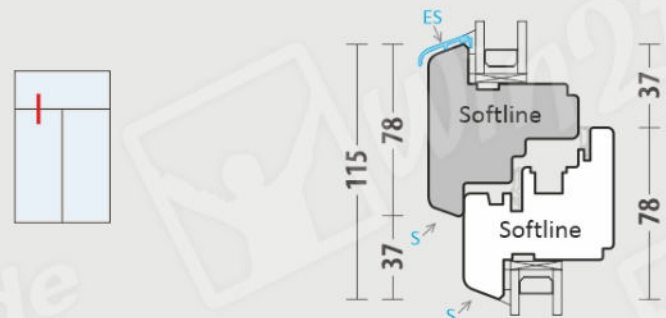
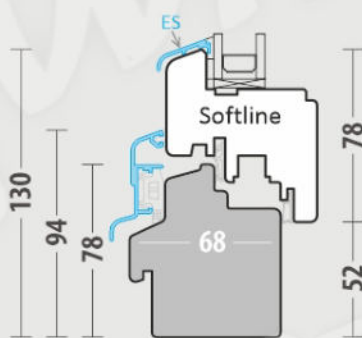
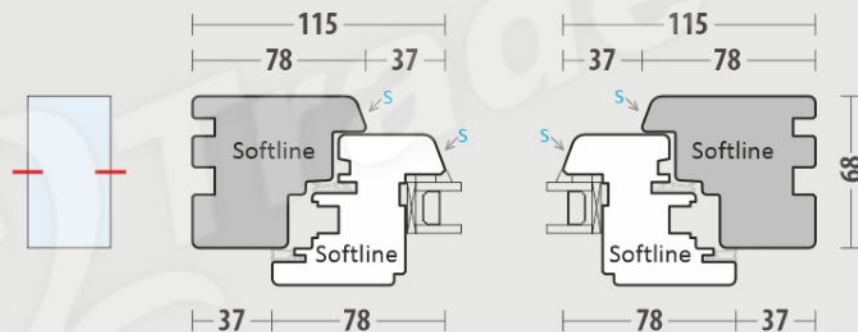
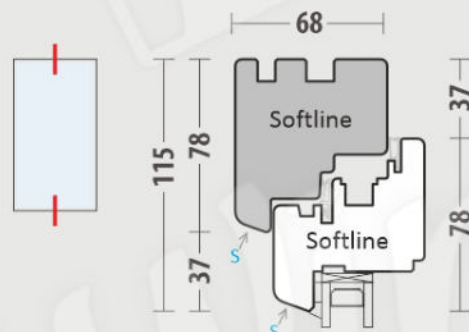
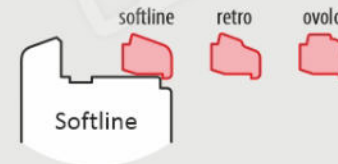

WINDOWS Eco 68

Basic cross-sections (Retro)

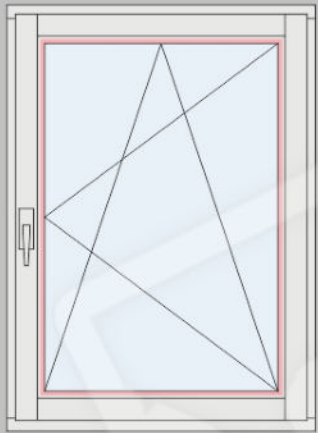

Eco
Retro



frame / sash

OPTIONS
GLAZING BEAD

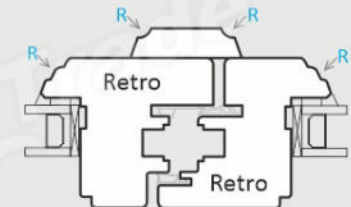
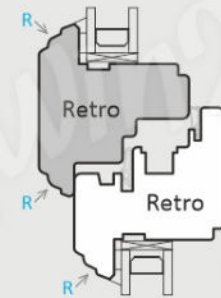
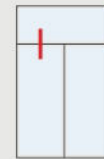
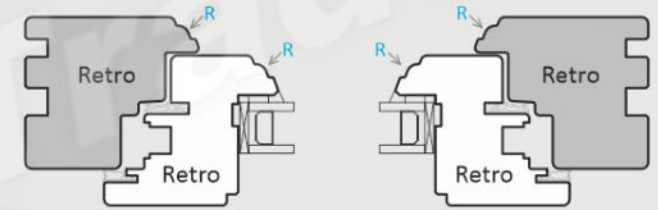
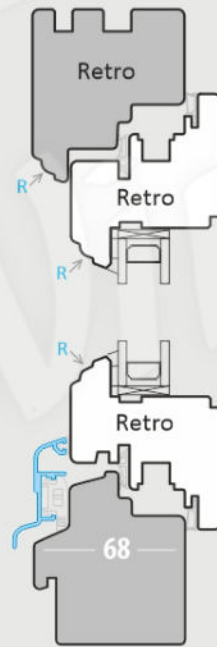

WINDOWS

Eco 68 | 78 | 92

Frame and sash installation depth



Eco
Softline



frame / sash

Eco
Retro



frame / sash

OPTIONS
INSTALLATION DEPTHS

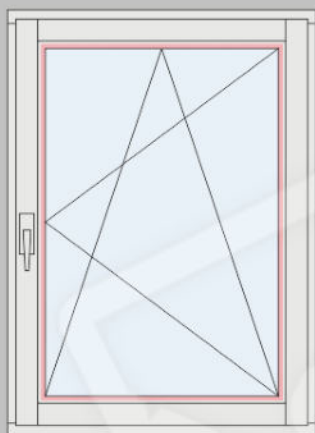

68

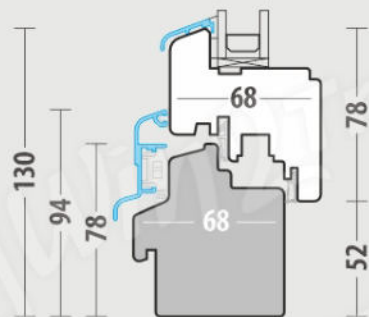
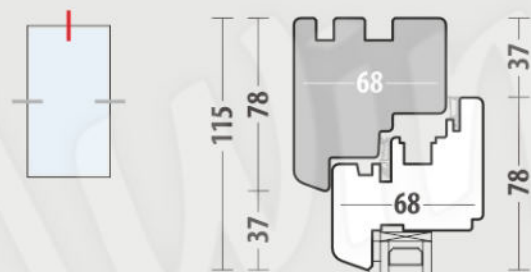

78

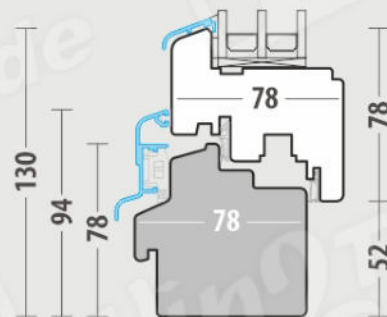
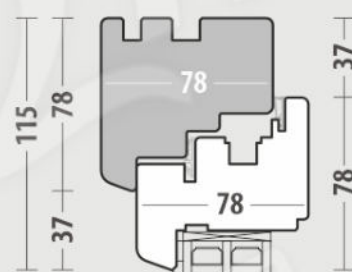

92

