



# WINDOWS Classic 68

Basic information

## Classic

Classic windows always have a visible wooden drip cap made of the same wood and in the same colour as the window.

The shape of the drip cap can be selected depending on chosen window finishing (Softline, Retro)

\* available installation depths:  
68, 78 i 92 mm.



Finish type

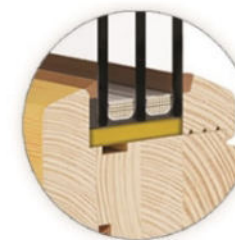

Softline



Retro



Thermal transmittance  $U_w$

1,01 - 1,37 W/m<sup>2</sup>K



Security / Burglary resistance

Rc1 - Rc2 class



Sound insulation

(depending on the glazing unit used)  
32 - 41 dB



Wind load resistance

C5 class

WINDOWS  
**Classic 68**  
Individual  
finish

A - sash drip cap  
B - sill

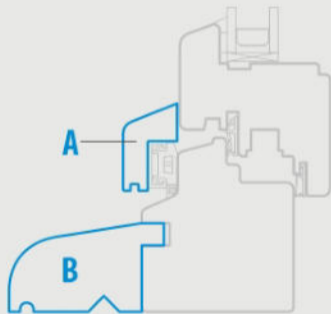

Sample combinations: A+B



A - C1R  
B - B0



A - C1S  
B - B0

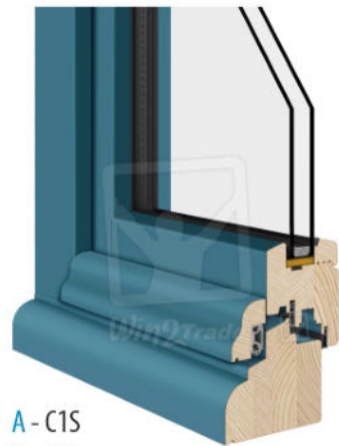

A - C1S  
B - R25



A - C2S  
B - R6

# WINDOWS Classic 68

Basic information

## CONSTRUCTION

Wooden frame made of glued laminated timber along the length and thickness from solid sawn timber.

Frame and sash installation depth: 68mm  
(78 and 92 mm are also available)

## MATERIAL



pine

meranti

oak

## GLASS

Energy-saving double- or triple-glazed units (double-chamber) made of low-emissivity glass with an argon-filled inter-pane space.



OPTIONAL :

- safety glass: laminated VSG, tempered ESG
- soundproof
- solar control
- maximum glazing package thickness for 68 mm profile is 32mm

## LAZURES



## EQUIPMENT

### STANDARD:

The basic model of the handle for Eco windows is the Hoppe metal handle, model **Tokyo** in white or brown.

### OPTIONAL:

- handles that increase safety, such as handles with button or handles with key
- handles with a lockable turned-opening
- vents mounted horizontally in the sash
- muntins: inter-pane, glued on, vienna bars and construction bars

## PAINTING

The joinery is painted with water-based, eco-friendly, transparent or opaque varnishes.

OPAQUE COLOURS according to the RAL or NCS palette  
LAZURES highlight the wood structure.



\* As standard, the colour inside and outside is identical.

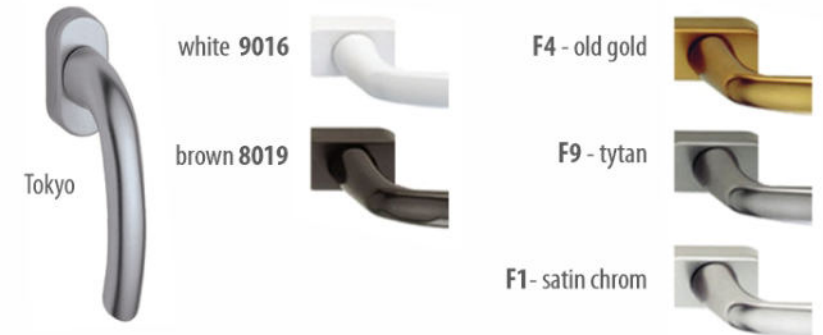

WINDOWS

# Classic 68

Basic cross-sections ( Softline )

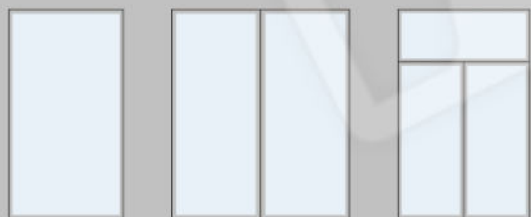
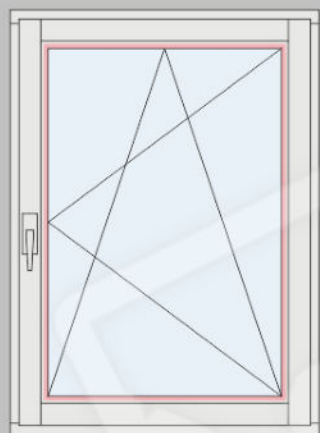

## Classic Softline



frame / sash

## OPTIONS GLAZING BEAD

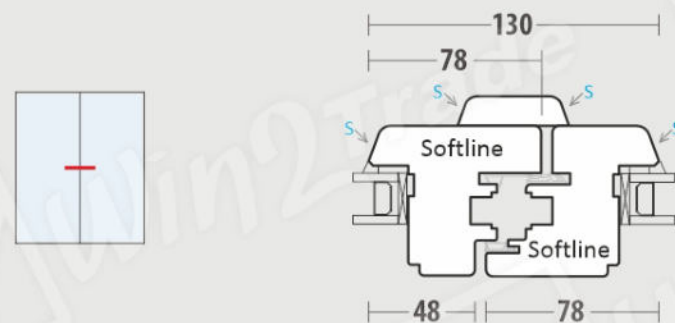
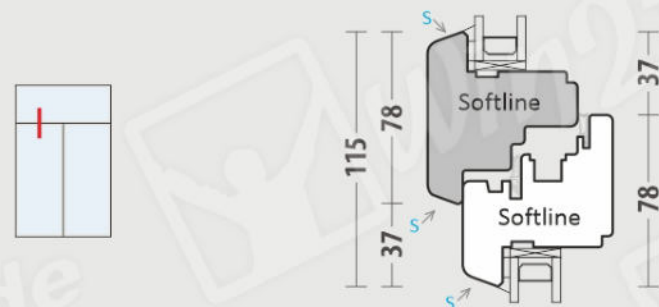
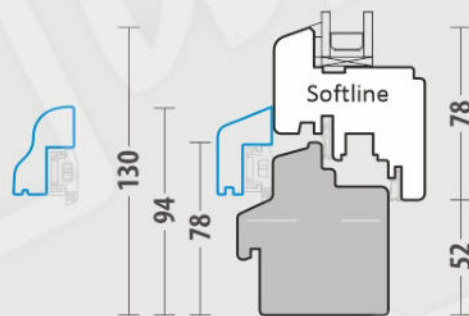
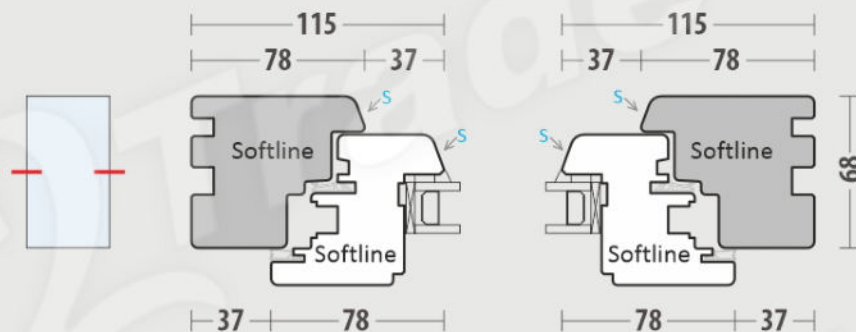
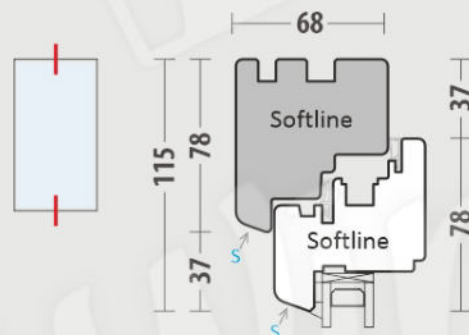
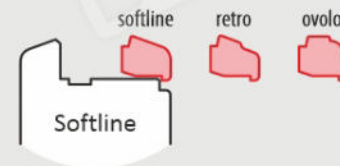

# WINDOWS

## Classic 68

Basic cross-sections ( Retro )

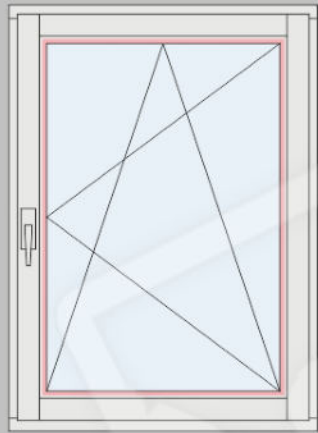

Classic  
**Retro**



frame / sash

OPTIONS  
GLAZING BEAD

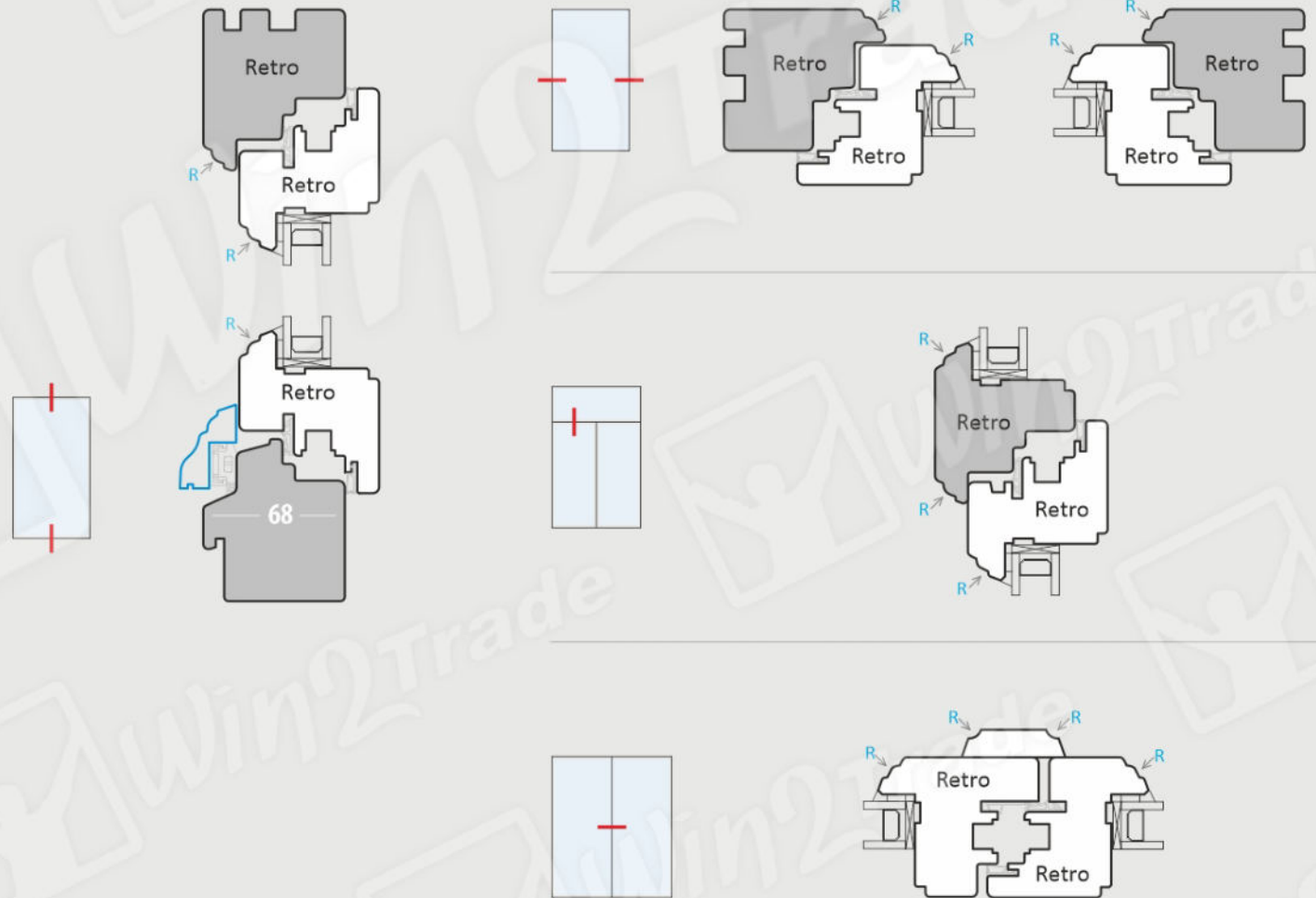

WINDOWS

# Classic 68 | 78 | 92

Frame and sash installation depth



Classic  
**Softline**



frame / sash

Classic  
**Retro**



frame / sash

OPTIONS  
INSTALLATION DEPTHS

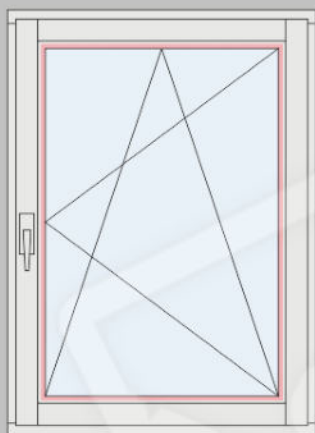

68

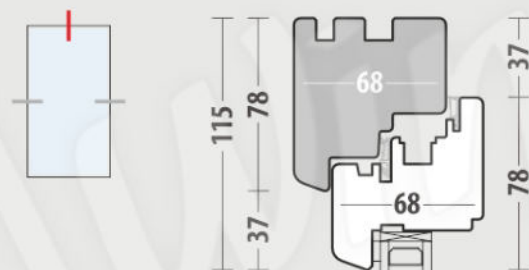

78

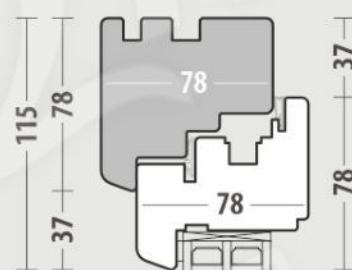

92

