



VOLETS MONOBLOC CC / TL / TP / TP+

Volets Monobloc

Les volets monobloc sont montés directement sur le dormant de la fenêtre. Le caisson du volet roulant est placé par le haut sur le cadre de la fenêtre ou de la porte. L'accès au service du caisson se fait toujours depuis l'intérieur de la pièce.

Le volet peut être commandé (montée/descente) manuellement – à l'aide d'un sangle ou d'une manivelle à Cardan, ou électriquement – à l'aide de l'interrupteur ou d'une télécommande. La couleur du tablier et du caisson peut être sélectionnée parmi une large gamme de couleurs.

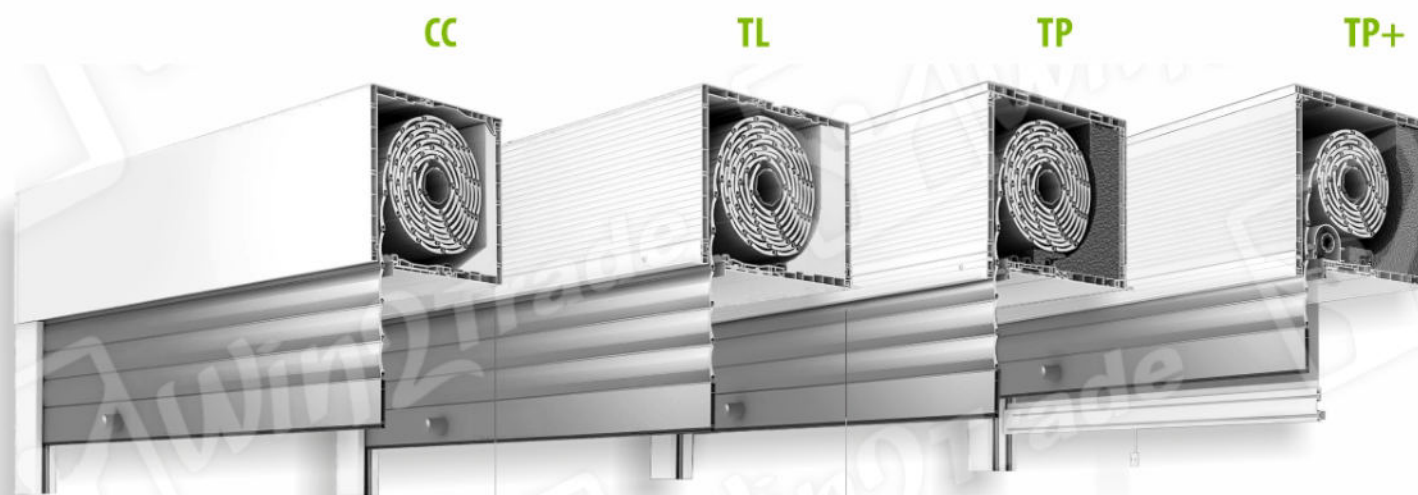

CC

Caisson:

162 x 135/140 mm
186 x 160/166 mm
228 x 200/206 mm

TL

Caisson:

253 x 161/165 mm
253 x 200/203 mm

TP / TP+

Caisson:

255 x 192/180 mm
255 x 232/220 mm
255 x 262/250 mm

VOLETS MONOBLOC

Tablier

Volets: **CC / TL / TP / TP+**

Tablier

Un élément important de chaque volet roulant est le tablier composé de profils en aluminium. Les profilés sont fabriqués à partir de tôle d'aluminium laminée puis revêtus de poudre. Chaque profil est doté d'un remplissage en mousse de polyuréthane (sans CFC). Grâce à cela, ils offrent une excellente isolation acoustique et thermique. Le choix du tablier dépend de la largeur du volet roulant.



Le tablier perforé permet de ventiler la pièce lorsque les stores sont fermés, tout en éclairant l'intérieur.)

PA 39

largeur maximale du volet: 2500 mm

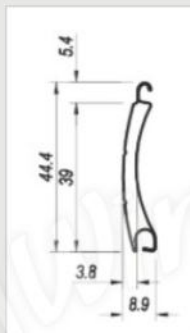

sans perforation

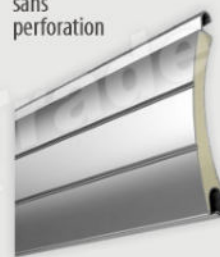

avec perforation



Couleurs

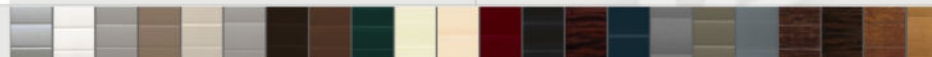

PA 45

largeur maximale du volet: 3000 mm

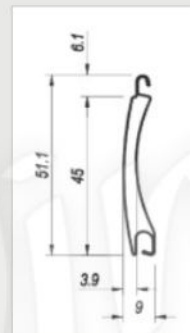

sans perforation



avec perforation



Couleurs

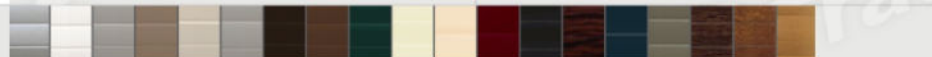

PA 52

largeur maximale du volet: 3700 mm

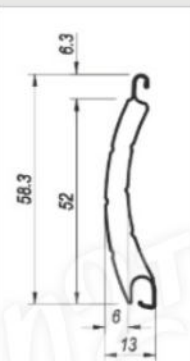

sans perforation

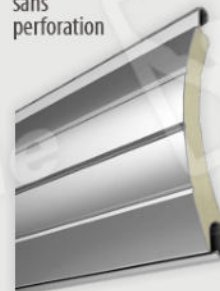

avec perforation



Couleurs

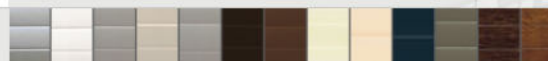

VOLETS MONOBLOC

Commande de volet roulant

CC / TL / TP



MANOUVRE MANUELLE

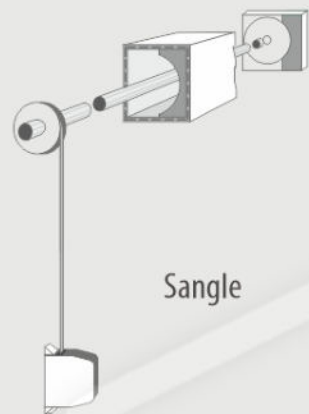

Sangle

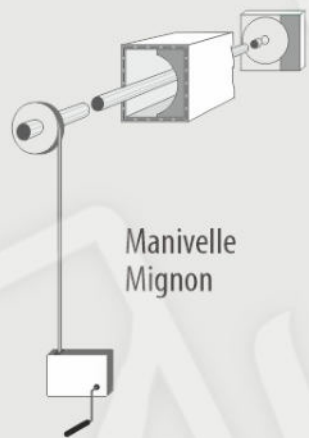

Manivelle
Mignon

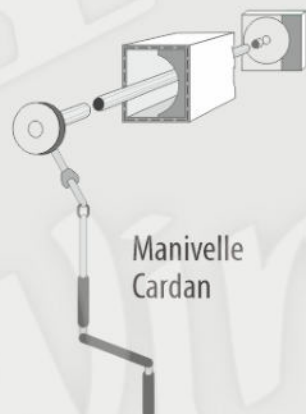

Manivelle
Cardan

MOTORISATION

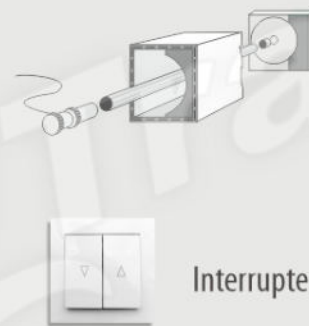

Interrupteur



télécommande

VOLETS MONOBLOC
Classic CC-1000

Sections de base (Coulisse RK-16)



CC-1000

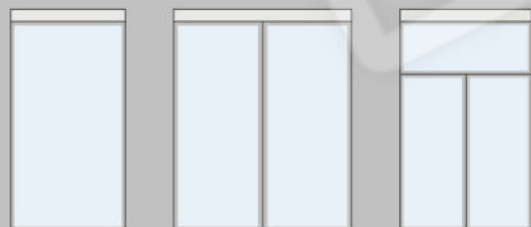

CC-1000

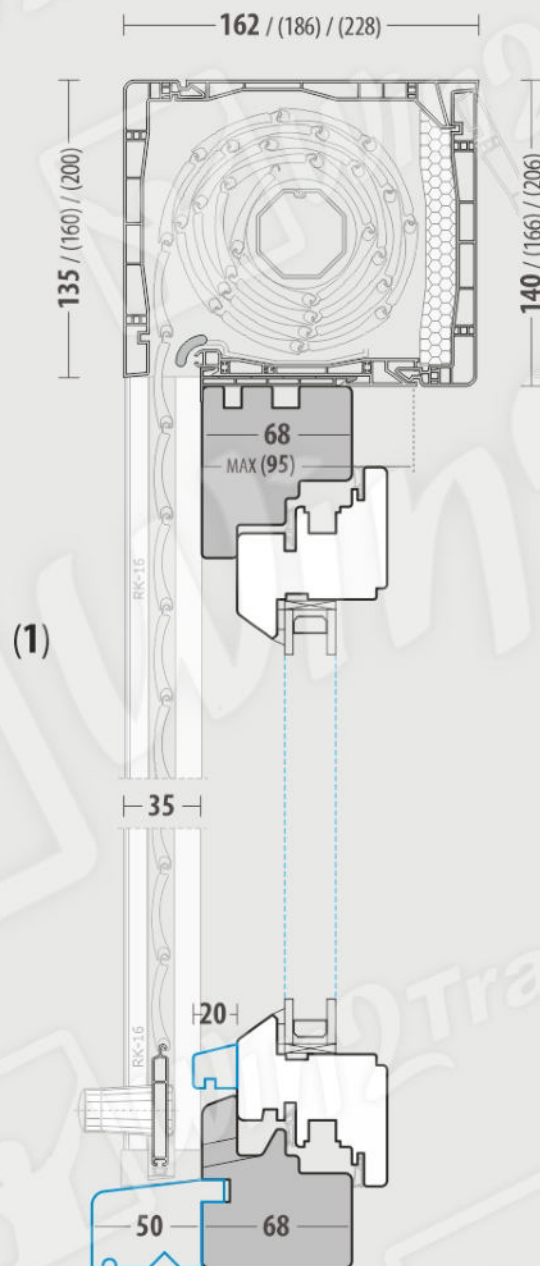

**Coulisse
 RK-16**

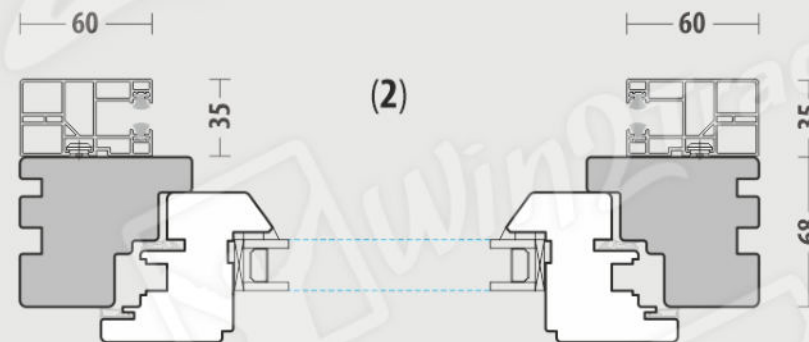
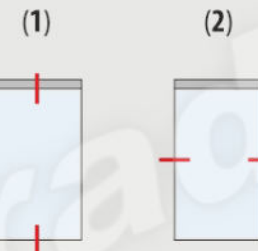

Trappe de revision



VOLETS MONOBLOC
TL / Thermo Lux /
 Sections de base (Coulisse RK-16)

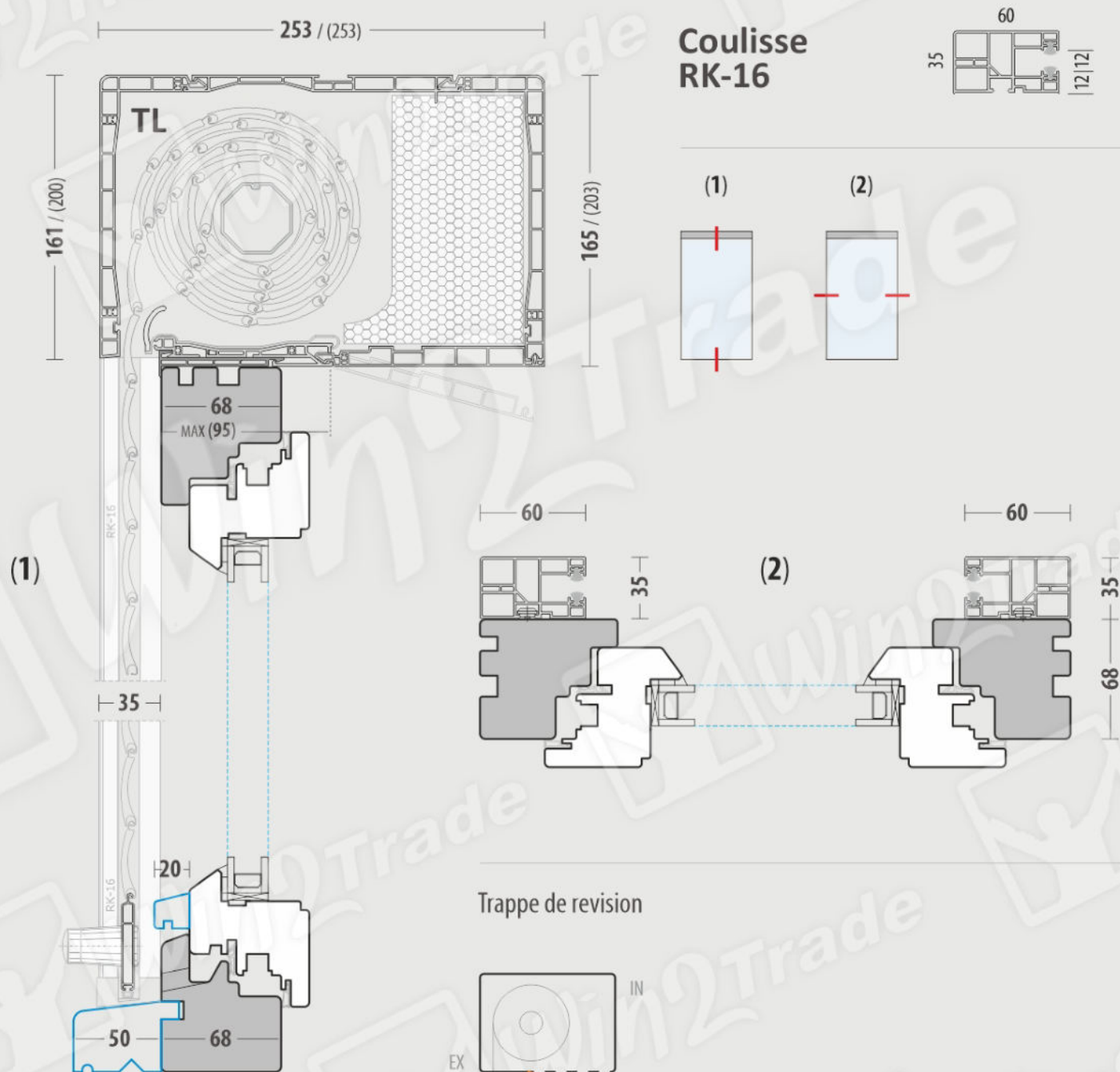
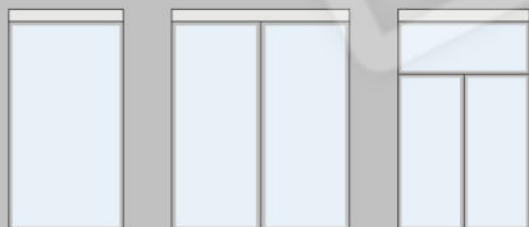

VOLETS MONOBLOC

TP / Thermo Prestige /

Sections de base (Coulisse NPR-020)



TP

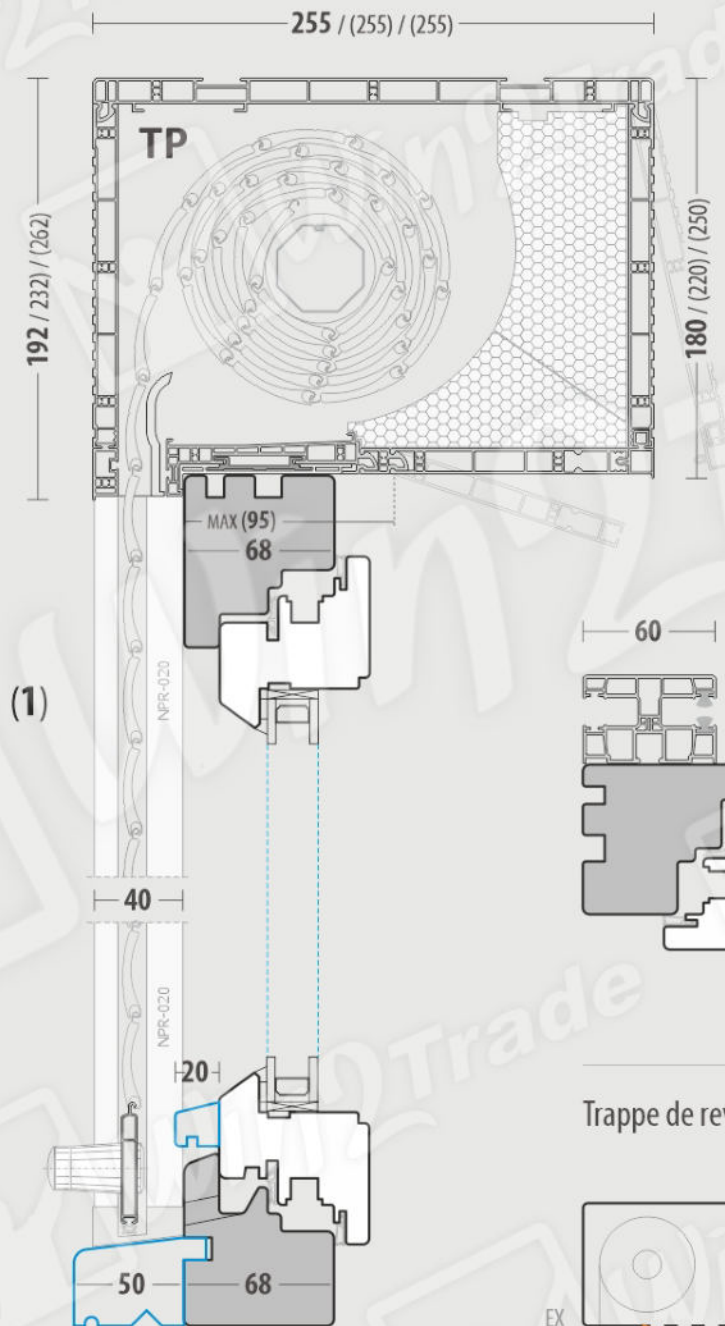
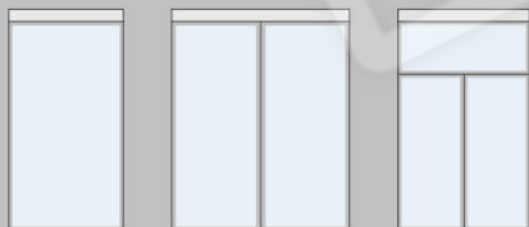

Coulisse NPR-020

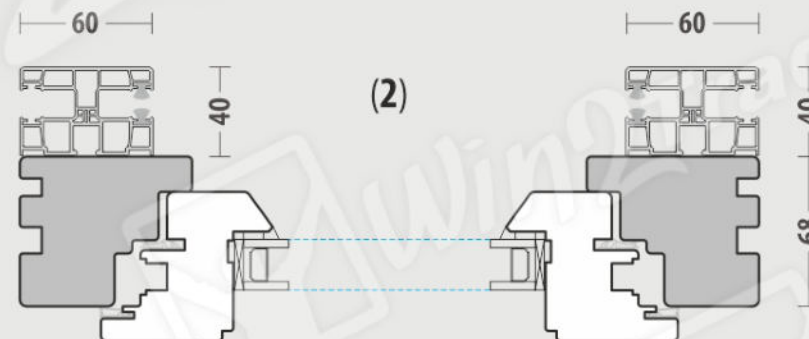
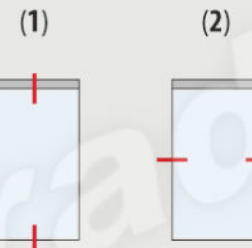
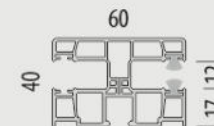

Trappe de revision

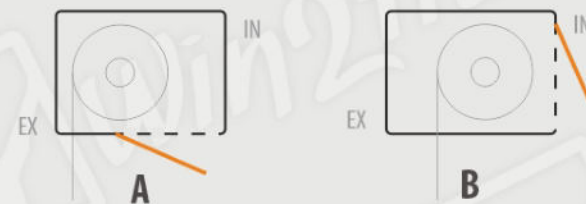

VOLETS MONOBLOC

TP+ / Thermo Prestige /
avec moustiquaire (Coulisse NPR-010)



TP+

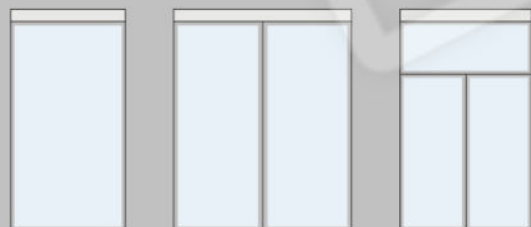

www.win2trade.fr

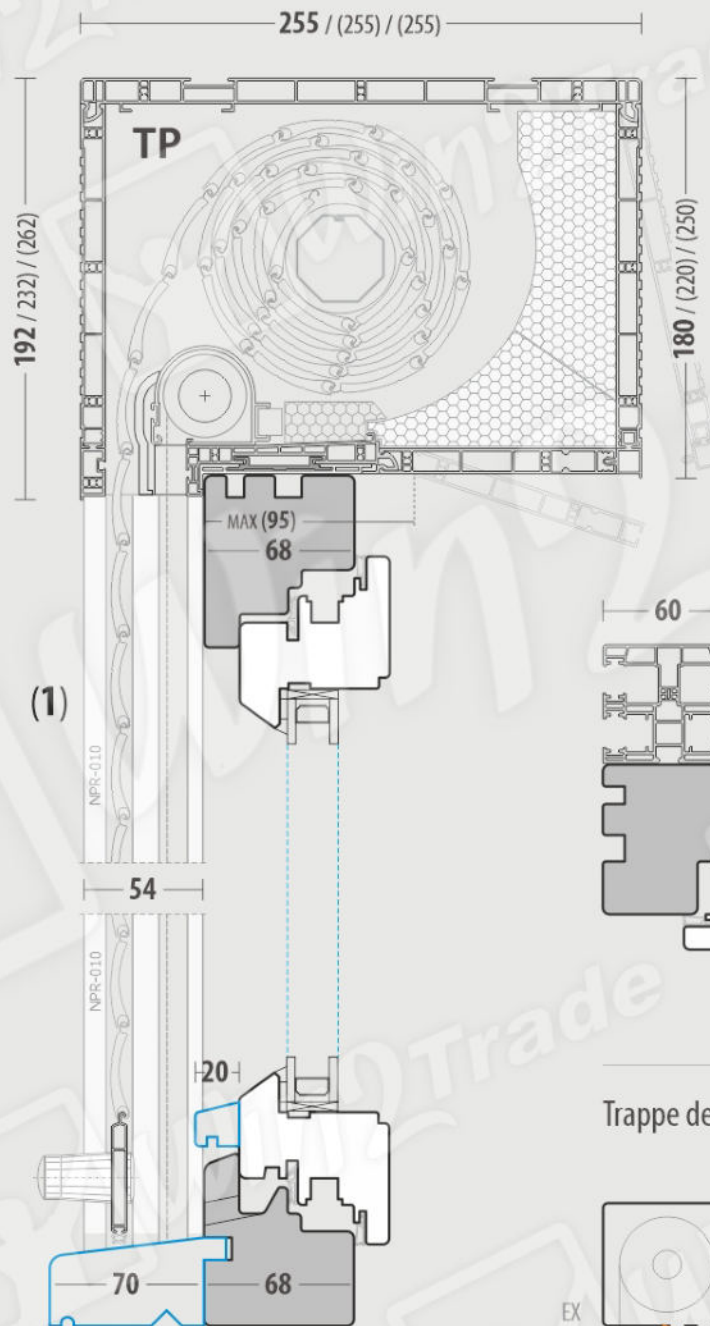

Coulisse NPR-010

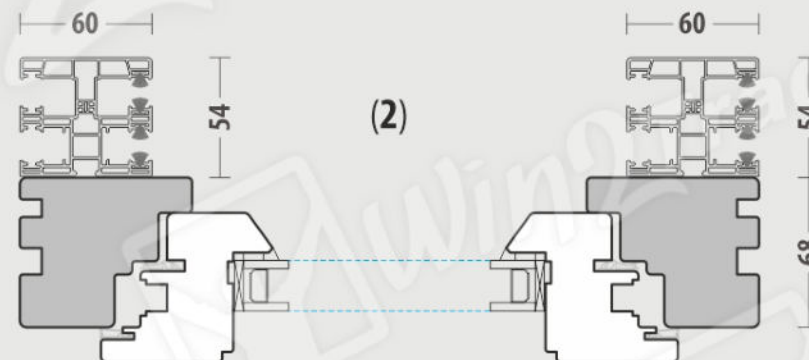
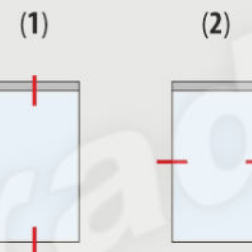
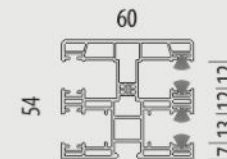

Trappe de revision

