



Portes-fenêtres

Les portes-fenêtres sont équipées d'une poignée double face et permettent de verrouiller la porte des deux côtés.

Un seuil bas permet un accès facile à la terrasse ou au balcon.

Selon l'usage prévu de la porte, vous pouvez choisir le type de seuil approprié.

Seuils disponibles :

- aluminium (h= 20, 32 mm),
- bois (h=32)
- système sans seuil (joint automatique ou à brosse)

* Profondeur de: 68, 78, 92 mm.



Transmission thermique Uw

1,01 - 1,37 W/m²K



Sécurité / Anti-effraction

Classe: Rc1 - Rc2



Insonorisation

32 - 41 dB (selon le vitrage utilisé)



Résistance au vent

Classe: C5

Portes-fenêtres

Informations de base



Types de seuils:



Aluminium - 20mm



Aluminium - 20mm
avec revêtement
de masquage



Aluminium - 32mm



Bois - 32 mm



joint tombant
automatique



joint à brosse

Portes-fenêtres

Informations de base

CONSTRUCTION

Cadre en bois massif lamellé-collé sur toute la longueur et l'épaisseur.

Profondeur d'installation du dormant et de l'ouvrant: 68 mm (78 et 92 mm disponibles)

MATÉRIAU



pin

méranti

chêne

VERRE

Verre à double ou triple vitrage (deux chambres) à économie d'énergie, composé de verre à faible émissivité, avec intercalaire rempli d'argon.



EN OPTION:

- verre de sécurité : verre feuilleté, verre trempé
- verre insonorisant
- verre de protection solaire
- épaisseur maximale du vitrage pour 68 mm : 32 mm

LAQUES



ÉQUIPEMENT

STANDARD:

Le modèle de base de la poignée pour portes-fenêtres est une poignée double face avec plaque.

EN OPTION:

- Poignées de fenêtre double face avec rosace
- Poignées sous le volet roulant
- aérateurs montés horizontalement dans l'ouvrant ou dormant
- aérateurs montés horizontalement sur le vitrage
- petits bois: intègres, collés, viennois, de construction

PEINTURE

La menuiserie est peinte avec des vernis hydrosolubles, écologiques, transparents ou opaques.

COULEURS OPAQUES elon la palette : RAL ou NCS
LAQUES révélant la structure du bois.



* En standard la couleur intérieure et extérieure est identique.



Poignées de porte double face



9016
Blanc

8019
Brun

F4
Doré

F9
Tytan

F1
Argenté

Poignées de fenêtre double face avec rosace



9016
Blanc

8019
Brun

F4
Doré

F9
Tytan

F1
Argenté



Poignée
sous le volet roulant

Serrure



standard
double face



avec un bouton



Portes-fenêtres

La porte-fenêtre à seuil bas améliore le confort d'utilisation, notamment pour les personnes handicapées et les enfants.

Portes-fenêtres

Types de seuils

Seuil en aluminium
- 20 mm

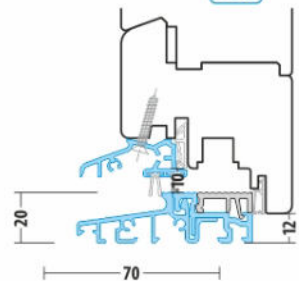

Seuil en aluminium
- 20 mm
avec revêtement de masquage

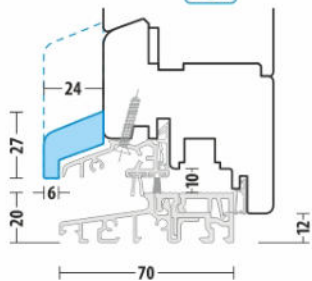

Seuil en aluminium
- 32 mm

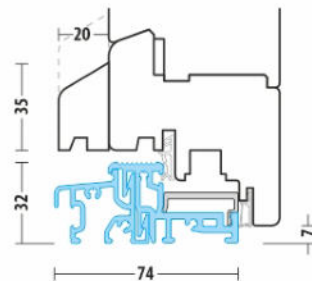

Seuil en bois - 32 mm

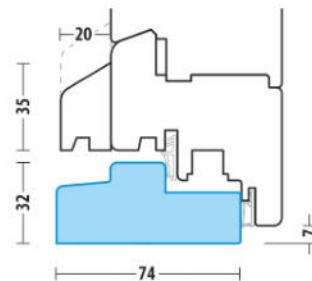

Système sans seuil
(joint tombant automatique)

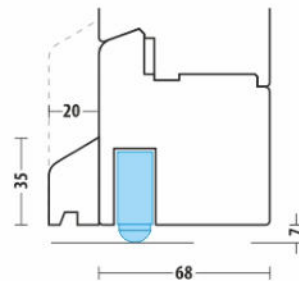

Système sans seuil
(joint à brosse)

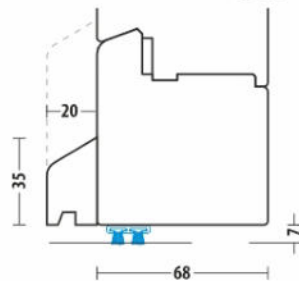

OPTIONS

Dormant / Ouvrant / Parclose

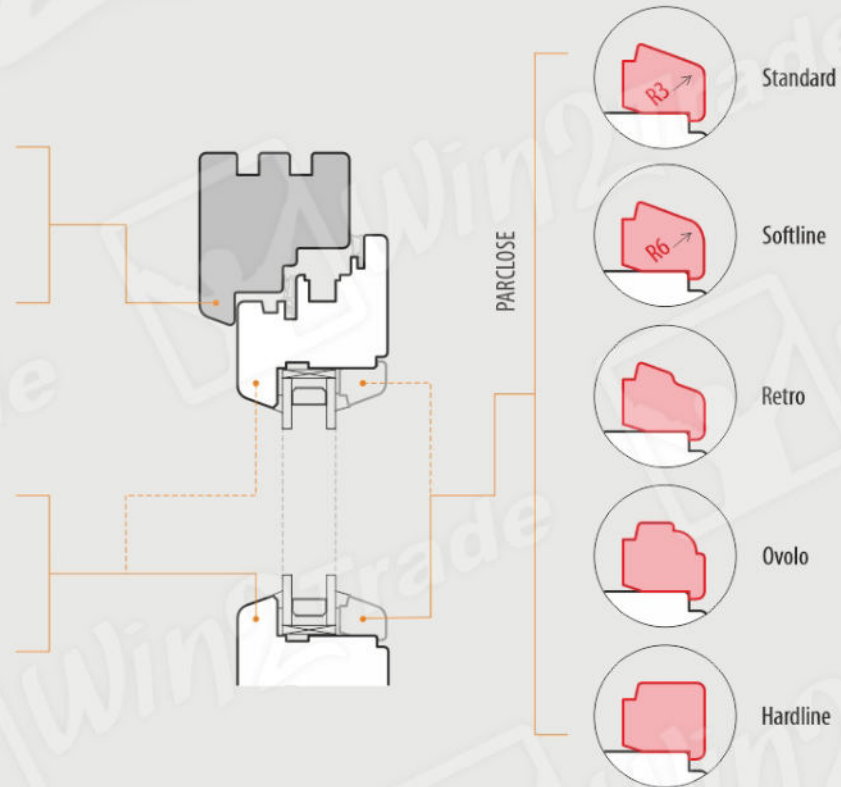
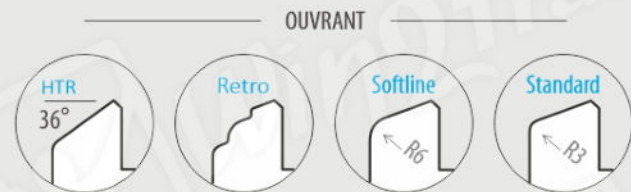
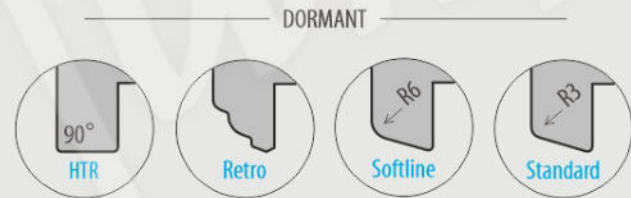

Portes-fenêtres 68

Profils de base



Softline

Dormant



Softline

Ouvrant

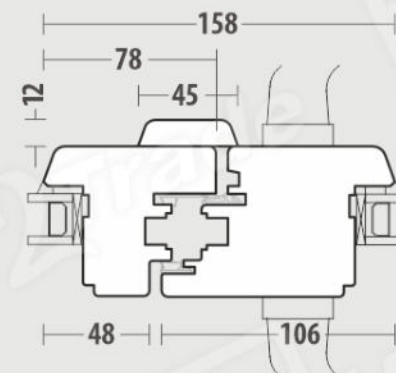
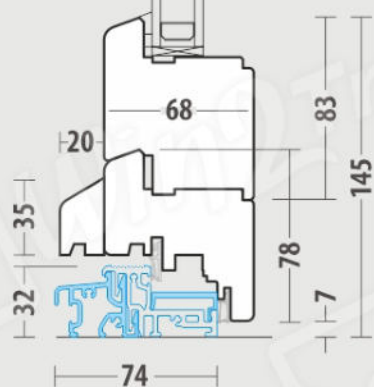
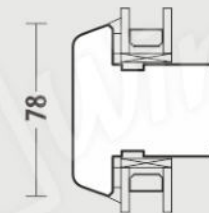
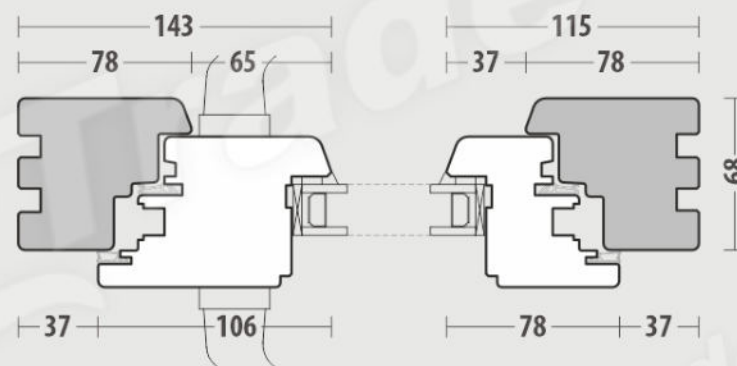
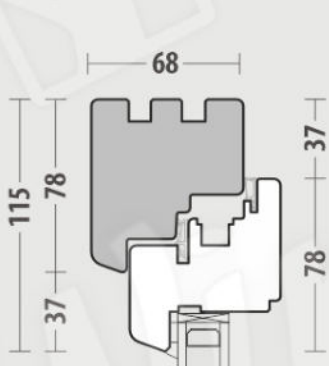
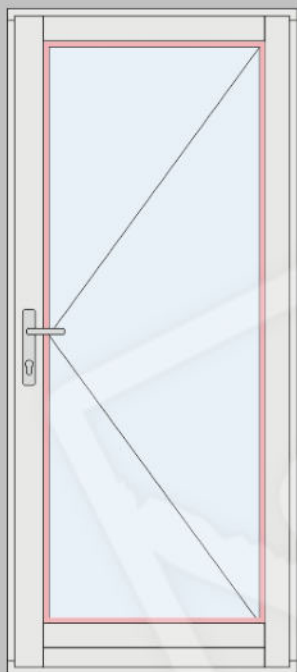

Portes-fenêtres 68|78|92

Profondeur d'installation du cadre et du vantail



Softline

Dormant



Softline

Ouvrant

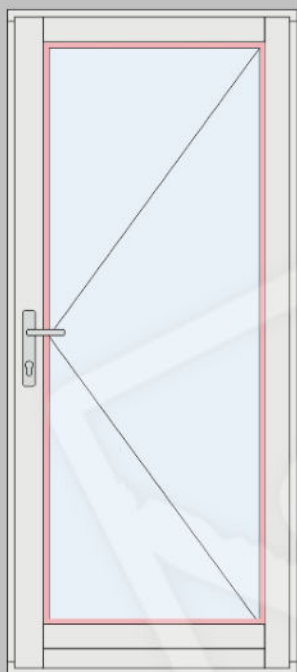

www.win2trade.fr

EN OPTION
Profondeur d'installation

68

78

92

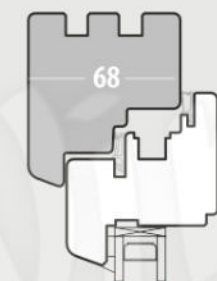
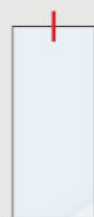

24-32

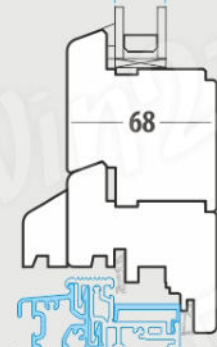

74

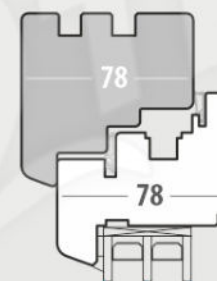

24-42

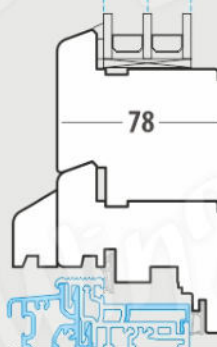

84

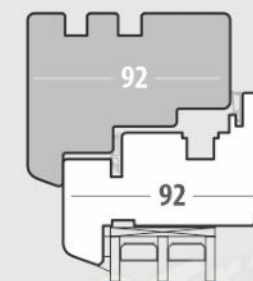

24-55

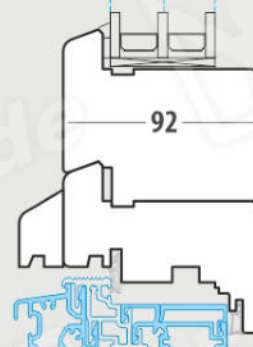

96

