



## Traditional

Les fenêtres Traditional ont toujours un rejet d'eau en bois monté sur l'ouvrant, visible de l'extérieur.

Selon le pays (région), le seuil de fenêtre peut avoir une finition différente - le plus souvent sous la forme d'un appui de fenêtre extérieur en bois, fixé en permanence à la fenêtre.

\* Profondeur de: 68, 78, 92 mm.



Transmission thermique Uw

1,01 - 1,37 W/m<sup>2</sup>K



Sécurité / Anti-effraction

Classe: Rc1 - Rc2



Insonorisation

32 - 41 dB (selon le vitrage utilisé)



Résistance au vent

Classe: C5

# FENÊTRES Traditional 68

Informations de base



Type de finition

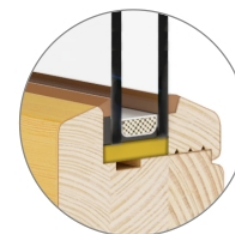

Softline

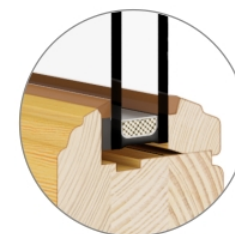

Retro

# FENÊTRES Traditional 68

Informations de base

## CONSTRUCTION

Cadre en bois massif lamellé-collé sur toute la longueur et l'épaisseur.

Profondeur d'installation du dormant et de l'ouvrant: 68 mm (78 et 92 mm disponibles)

## MATÉRIAU



pin

méranti

chêne

## VERRE

Verre à double ou triple vitrage (deux chambres) à économie d'énergie, composé de verre à faible émissivité, avec intercalaire rempli d'argon.



EN OPTION :

- verre de sécurité : verre feuilleté, verre trempé
- verre insonorisant
- verre de protection solaire
- épaisseur maximale du vitrage pour 68 mm : 32 mm

## LAQUES



## ÉQUIPEMENT

### STANDARD:

Le modèle de base de la poignée pour fenêtres Traditional est la poignée métallique Hoppe **Tokyo**, blanche ou marron.

### EN OPTION:

- poignées de sécurité, dites à bouton ou à clé.
- poignées avec possibilité de blocage de la fonction d'ouverture.
- CREMONE avec un adaptateur.
- aérateurs montés horizontalement dans l'ouvrant.
- petits bois: intègres, collés, viennois, de construction

## PEINTURE

La menuiserie est peinte avec des vernis hydrosolubles, écologiques, transparents ou opaques.

COULEURS OPAQUES elon la palette : RAL ou NCS  
LAQUES révélant la structure du bois.



\* En standard la couleur intérieure et extérieure est identique.

Poignées Hoppe - autres modèles



# FENÊTRES Traditional 68

Profils de base (Softline)

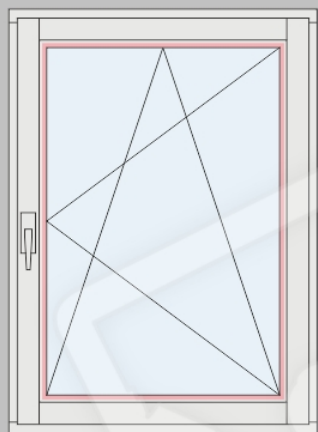

## Traditional Softline



dormant / ouvrant

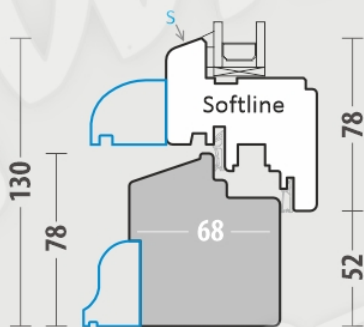
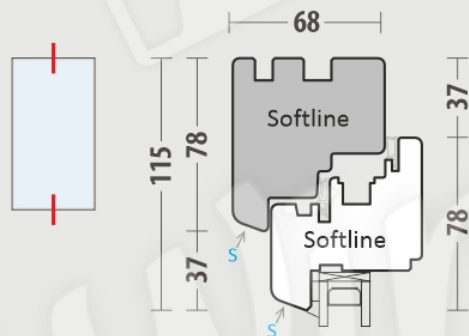

EN OPTION - PARCLOSE

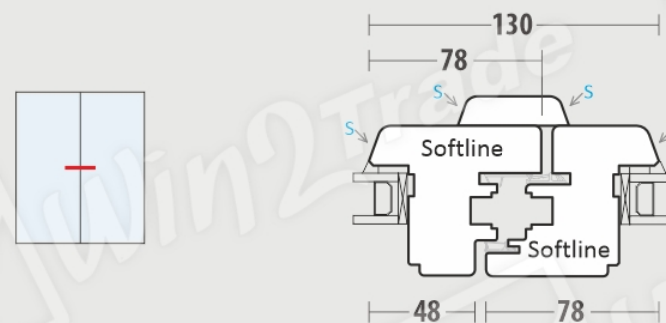
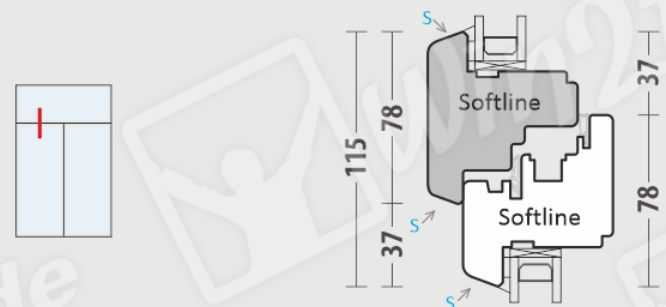
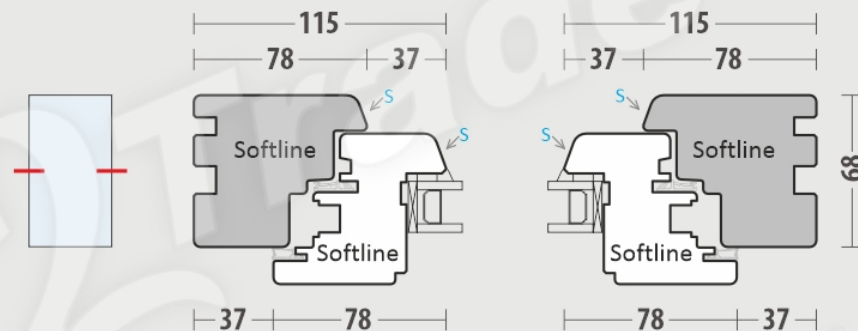

# FENÊTRES Traditional 68

Profils de base ( Retro )

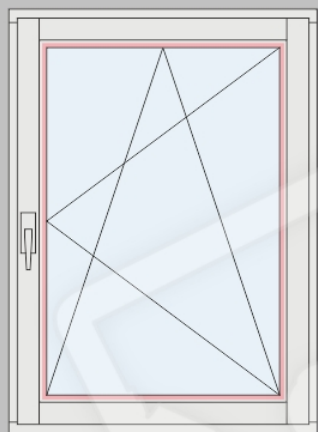

## Traditional Retro



dormant / ouvrant

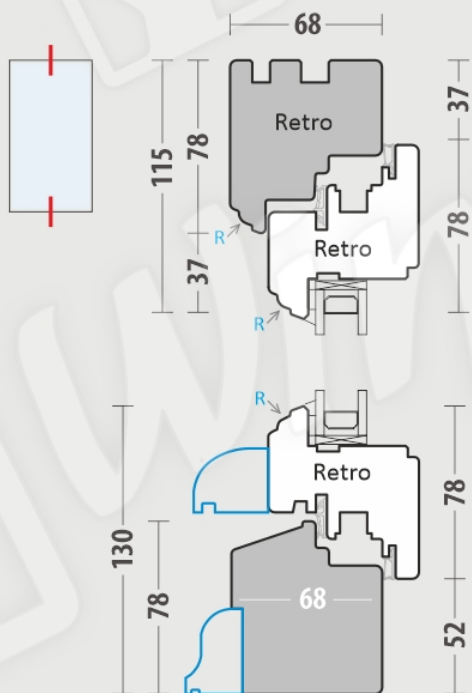

EN OPTION - PARCLOSE

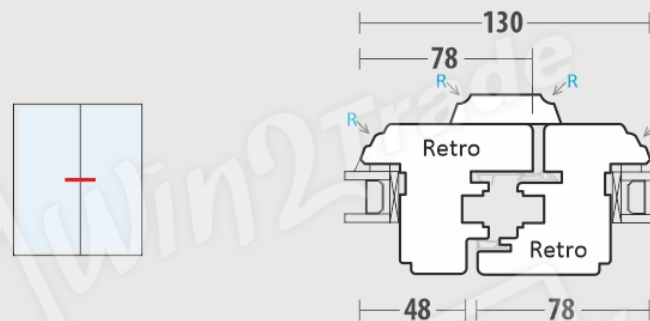
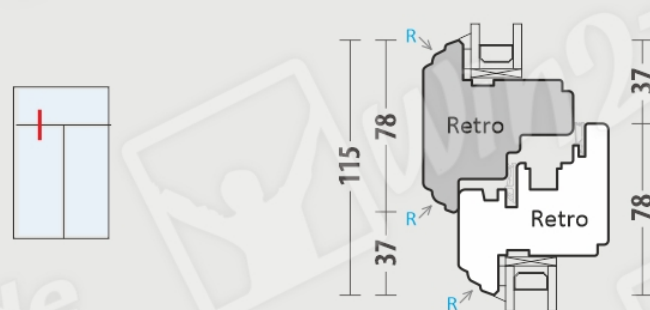
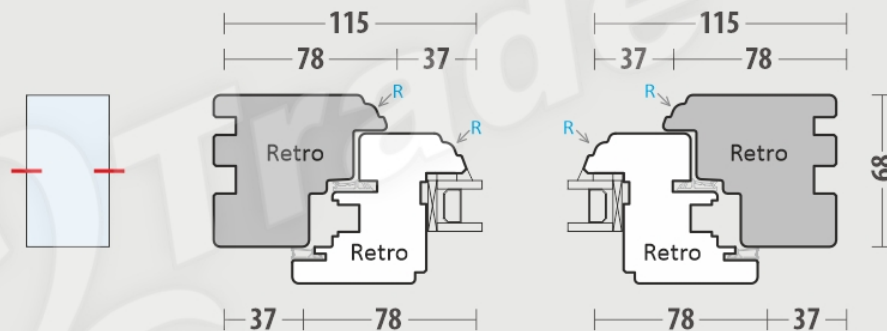

# OPTIONS

## Rejets d'eau

A - ouvrant, B - dormant



### Traditional Softline Retro

A



**PS**



**BS**



B

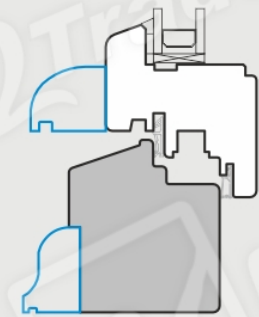
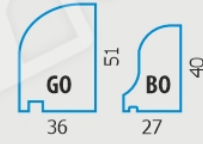
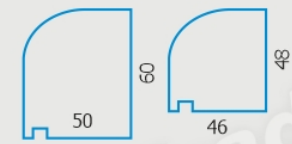

# Appuis de fenêtre

(extérieurs)



**R-6**

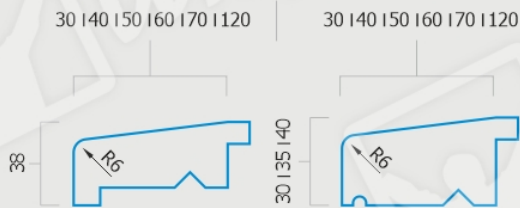

**R-25**

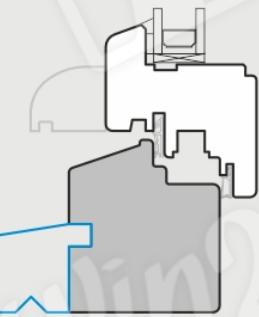
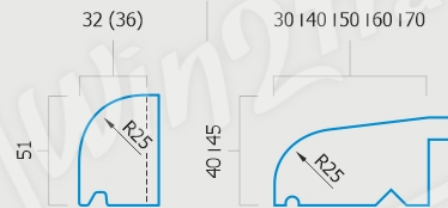

FENÊTRES

# Traditional 68|78|92

Profondeur d'installation du cadre et du vantail

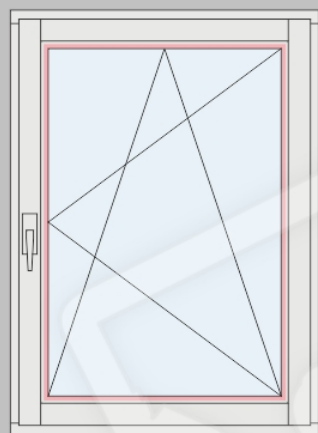

Traditional  
**Softline**



dormant / ouvrant

Traditional  
**Retro**



dormant / ouvrant

EN OPTION  
Profondeur d'installation

68

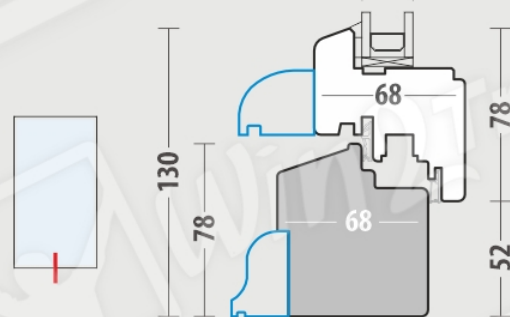
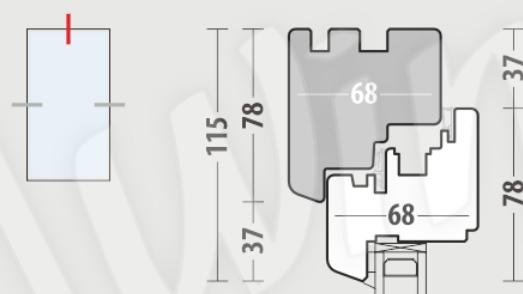

78

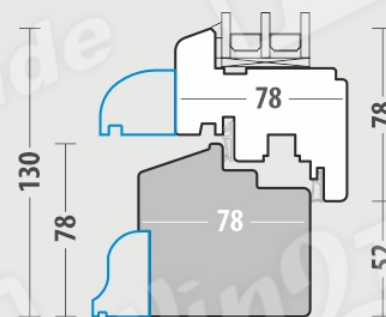
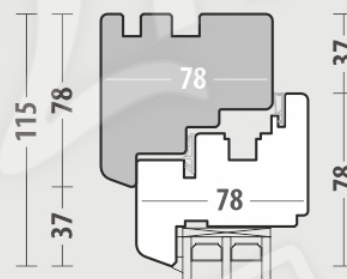

92

